

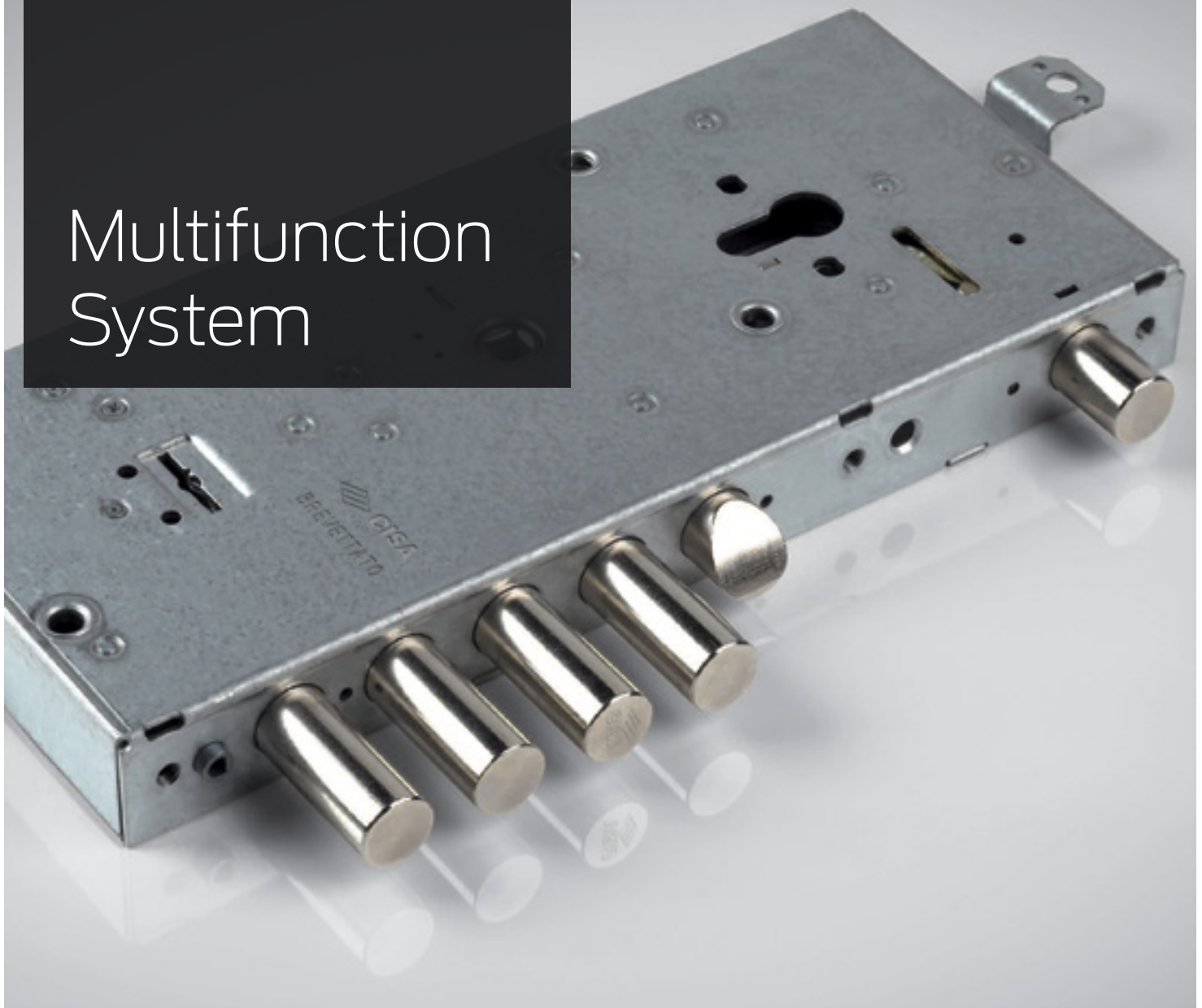

# Multifunction System



# Multifunction System

## OPERATION

- Two locks coupled to obtain a single product performing different functions for enhanced handiness and security: version with security lock, version with service lock and version with service lock and opening limiting device.
- In the double bit key New Cambio Facile models, the lock key bitting can be changed at any time. Thanks to the patented New Cambio Facile System, the keys can be changed easily, without having to disassemble the lock or any part of it, by just using the keys. With New Cambio Facile, the keys may be changed for a virtually limitless number of times.
- The Revolution models (with European profile cylinders) are fitted with a special, effort-reducing gear mechanism which ensures smooth key rotation when operating the lock.

## SECURITY

### Cylinder version

- In the Revolution models, security is guaranteed by the CISA European profile cylinders, true technological jewels.
- The Revolution System, installed with the CISA cylinders AP3 and/or RS3, and series 06480 and/or 06485 protective roses, meets the top security requirements provided for by the European standards EN 1303 and UNI EN 12209:03.

### Double bitted key version

- Security is guaranteed by the 'independent key bitting' system patented by CISA.
- The double-bit key operates the 6 anti-friction levers arranged in two sets, separated by the deadbolt tang, each lever being activated by an independent helical spring.

- With the double-bit 6 lever CISA system, up to 244 million key differs are possible.

## RANGE

Developed according to 2 dimensional standards to meet any installation requirements.

## CERTIFICATES

CISA double locks for armoured doors have been designed and tested to meet the strictest requirements provided for by the Draft European Standard UNI EN 12209:03.

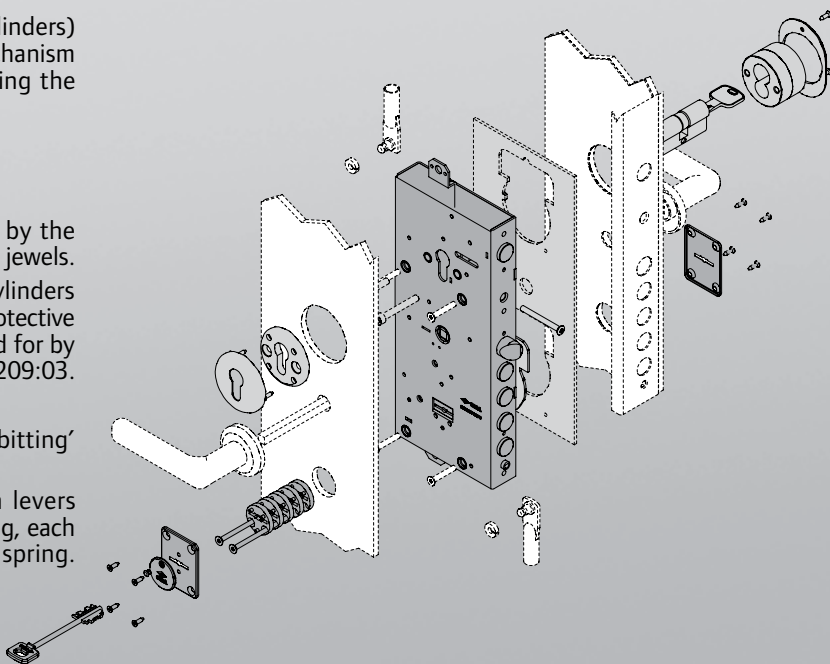



#### Operation:

- VERSION WITH SECURITY FUNCTION AND DEPENDENT LOCKS:
  - The secondary lock can be operated to lock the main lock when this is in its closed position. In the items with a double bit key main lock (standard and/or NEW CAMBIO FACILE), the secondary lock will block the key hole.
- VERSION WITH SECURITY FUNCTION AND INDEPENDENT LOCKS:
  - The secondary lock can be operated (to control the latchbolt and secondary deadbolt) even when the main lock is in its open position. The secondary lock will lock the main lock when this is in its closed position. In the items with a double bit key main lock (standard and/or NEW CAMBIO FACILE), the secondary lock will block the key hole.
- VERSION WITH SERVICE LOCK:
  - The secondary lock key will operate the latchbolt and secondary deadbolt.
  - The latchbolt can be remotely controlled electrically (electrically operated locks).
- VERSION WITH SERVICE KEY AND OPENING LIMITING DEVICE:
  - The secondary lock key will operate the latchbolt and secondary deadbolt; the opening limiting device is operated by controlling the secondary lock first throw.

#### Finishes:

- Zinc plated aluminium.

#### R./L. Hand Opening:

0 = non-handed.

#### Standard equipment:

- Keys (for double bit key locks only).

#### Technical features:







- Steel case and cover.
- Nickel-plated steel faceplate (mortice locks).
- Nickel-plated steel deadbolts.
- Non-handed nickel-plated latch-bolt.
- Anti-picking latch-bolt (electrically operated locks).
- Nickel-plated reloading pin (electrically operated locks).
- Coil set with built-in terminal block, 12 V, 15 W ac (electrically operated locks).
- Anti-crush plates for screw fixing.
- Steel active pins.
- Effort-reducing gear mechanisms operated by the key turning



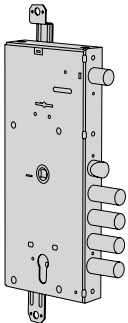

- in the cylinder (main cylinder lock).
- Traditional, 2-throw mechanism for the secondary lock.
- Pre-setting for additional locking points.
- Packaging: 1 or 5 pieces (industrial packs).

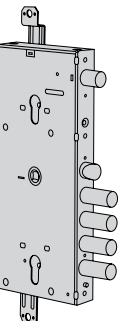
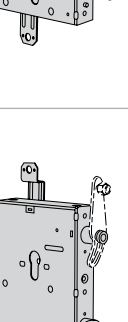
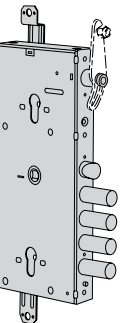



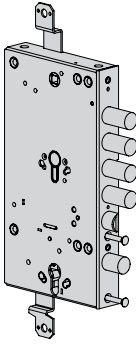
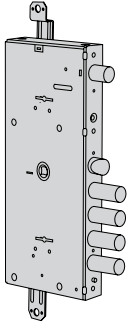

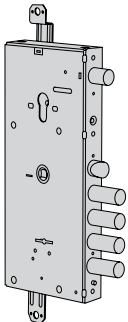

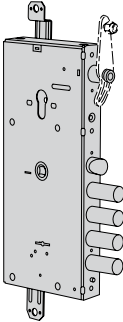

#### On request:



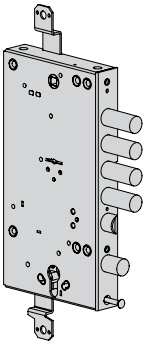



- European profile cylinder (specific items).
- Chain for limiting device (specific items).
- Protective roses series 06460, 06480, 06485 for cylinder operated locks.
- Protective roses series 06082, 06143, 06144, 06145 for double bit locks.

Type	Description	Item key	Dead-bolts							ITEM							
			No.	Projection	Distance	Throws	Distance	Faceplate	Backset	Unit weight Kg	Pieces	Type	Dim.	Hand	Fin.	Pers.	Spec.
	<ul style="list-style-type: none"> <li>• VERSION WITH SERVICE LOCK</li> <li>• 2-throw cylinder secondary lock</li> <li>• 2-throw cylinder main lock</li> <li>• Electrically controlled dead-locking latch-bolt</li> <li>• Voltage: 12 V ac CE</li> <li>• Slide item 1.06224.50.0</li> </ul>		-	3,5	28	-	85	-	64	2,900	1	<b>1 16766 28 0</b>					
			-	3,5	28	-	85	-	64	3,140	5	<b>1 16766 48 0</b>					
	<ul style="list-style-type: none"> <li>• VERSION WITH SERVICE LOCK</li> <li>• 2-throw cylinder secondary lock</li> <li>• Double bit 6 lever main lock</li> <li>• Electrically controlled dead-locking latch-bolt</li> <li>• Voltage: 12 V ac CE</li> <li>• Slide item 1.06224.50.0</li> </ul>	 3 item 1 00123 00 1	-	3,5	28	-	85	-	64	3,100	1	<b>1 17766 28 0</b>					
			-	3,5	28	-	85	-	64	2,880	5	<b>1 17766 48 0</b>					
	<ul style="list-style-type: none"> <li>• VERSION WITH SERVICE LOCK</li> <li>• 2-throw cylinder secondary lock</li> <li>• Double bit 6 lever NEW CAMBIO FACILE 4-throw main lock</li> <li>• Electrically controlled dead-locking latch-bolt</li> <li>• Voltage: 12 V ac CE</li> <li>• Slide item 1.06224.50.0</li> </ul>	 3 item 1 00163 00 1	-	3,5	28	-	85	-	64	3,400	1	<b>1 17916 28 A</b>					
			-	3,5	28	-	85	-	64	3,100	5	<b>1 17916 48 A</b>					
	<ul style="list-style-type: none"> <li>• VERSION WITH SERVICE LOCK</li> <li>• 2-throw cylinder secondary lock</li> <li>• Double bit 6 lever NEW CAMBIO FACILE 4-throw main lock with construction key</li> <li>• Electrically controlled dead-locking latch-bolt</li> <li>• Voltage: 12 V ac CE</li> <li>• Slide item 1.06224.50.0</li> </ul>	 3 item 1 00163 00 1   1 item 1 00120 00 1 (construction key)	-	3,5	28	-	85	-	64	3,500	1	<b>1 17966 28 A</b>					
			-	3,5	28	-	85	-	64	3,200	5	<b>1 17966 48 A</b>					

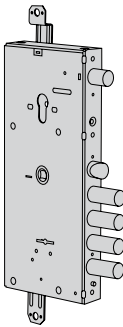
Type	Description	Item key	Dead-bolts							ITEM								
			No.	Projection	Distance	Throws	Distance	Faceplate	Backset	Unit weight Kg	Pieces	Type	Dim.	Hand	Fin.	Pers.	Spec.	
	<ul style="list-style-type: none"> <li>VERSION WITH SECURITY FUNCTION (dependent locks): the secondary lock can only be operated when the main lock is in its closed position.</li> <li>2-throw, 6 lever double bit secondary lock</li> <li>2-throw cylinder main lock</li> </ul>	 3 item 1 00123 00 1	-	3,5	28	-	85	-	64	3,100	1	<b>1 56715 28 0</b>						
			-	3,5	28	-	85	-	64	2,800	5	<b>1 56715 48 0</b>						
			<hr/>															
			<hr/>															
	<ul style="list-style-type: none"> <li>VERSION WITH SERVICE LOCK</li> <li>Double bit 6 lever 2-throw secondary lock</li> <li>2-throw cylinder main lock</li> </ul>	 3 item 1 00123 00 1	-	3,5	28	-	85	-	64	3,100	1	<b>1 56716 28 0</b>						
			-	3,5	28	-	85	-	64	2,800	5	<b>1 56716 48 0</b>						
			<hr/>															
			<hr/>															
	<ul style="list-style-type: none"> <li>VERSION WITH SECURITY FUNCTION (dependent locks): the secondary lock can only be operated when the main lock is in its closed position.</li> <li>2-throw, cylinder secondary lock</li> <li>2-throw, cylinder main lock</li> </ul>		-	3,5	28	-	85	-	64	2,900	1	<b>1 56765 28 0</b>						
			-	3,5	28	-	85	-	64	3,100	5	<b>1 56765 48 0</b>						
			<hr/>															
			<hr/>															
	<ul style="list-style-type: none"> <li>VERSION WITH SERVICE LOCK</li> <li>2-throw, cylinder secondary lock</li> <li>2-throw, cylinder main lock</li> </ul>		-	3,5	28	-	85	-	64	2,900	1	<b>1 56766 28 0</b>						
			-	3,5	28	-	85	-	64	2,600	5	<b>1 56766 48 0</b>						
			<hr/>															
			<hr/>															
	<ul style="list-style-type: none"> <li>VERSION WITH SERVICE LOCK AND OPENING LIMITING DEVICE OPERATED BY CYLINDER</li> <li>2-throw, cylinder secondary lock</li> <li>2-throw, cylinder main lock</li> <li>TO ORDER SEPARATELY - Chain for limiting device item 1.06421.10.1/2</li> </ul>		-	3,5	28	-	85	-	64	2,900	1	<b>1 56767 28 0</b>						
			-	3,5	28	-	85	-	64	2,600	5	<b>1 56767 48 0</b>						
			<hr/>															
			<hr/>															
	<ul style="list-style-type: none"> <li>VERSION WITH SERVICE LOCK AND OPENING LIMITING DEVICE, OPERATED BY THUMB TURN ONLY FROM INSIDE</li> <li>2-throw, thumb turn operated secondary lock</li> <li>2-throw, cylinder main lock</li> <li>TO ORDER SEPARATELY - Chain for limiting device item 1.06421.10.1/2</li> </ul>		-	3,5	28	-	85	-	64	2,900	1	<b>1 56768 28 0</b>						
			-	3,5	28	-	85	-	64	3,140	5	<b>1 56768 48 0</b>						
			<hr/>															
			<hr/>															

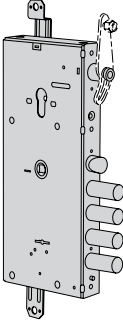

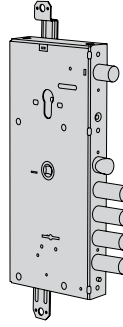



Type	Description	Item key	Dead-bolts							Unit weight		ITEM						
			No.	Projection	Distance	Throws	Distance	Faceplate	Backset	Kg	Pieces	Type	Dim.	Hand	Fin.	Pers.	Spec.	
	<ul style="list-style-type: none"> <li>VERSION WITH SECURITY FUNCTION (independent locks): the secondary lock can also be operated when the main lock is in its open position.</li> <li>2-throw, cylinder secondary lock</li> <li>2-throw, cylinder main lock</li> </ul>		-	3,5	28	-	85	-	64	3,100	1	<b>1 B6764 28 0</b>						
			-	3,5	38	-	85	-	64	3,100	1	<b>1 B6764 38 0</b>						
			-	3,5	28	-	85	-	64	2,900	5	<b>1 B6764 48 0</b>						
			-	3,5	38	-	85	-	64	2,900	5	<b>1 B6764 58 0</b>						
	<ul style="list-style-type: none"> <li>VERSION WITH SECURITY FUNCTION (dependent locks): the secondary lock can only be operated when the main lock is in its closed position.</li> <li>2-throw, cylinder secondary lock</li> <li>2-throw, cylinder main lock</li> </ul>		-	3,5	28	-	85	-	64	3,100	1	<b>1 B6765 28 0</b>						
			-	3,5	38	-	85	-	64	3,100	1	<b>1 B6765 38 0</b>						
			-	3,5	28	-	85	-	64	2,900	5	<b>1 B6765 48 0</b>						
			-	3,5	38	-	85	-	64	2,900	5	<b>1 B6765 58 0</b>						
	<ul style="list-style-type: none"> <li>VERSION WITH SERVICE LOCK</li> <li>2-throw, cylinder secondary lock</li> <li>2-throw, cylinder main lock</li> </ul>		-	3,5	28	-	85	-	64	3,100	1	<b>1 B6766 28 0</b>						
			-	3,5	38	-	85	-	64	3,100	1	<b>1 B6766 38 0</b>						
			-	3,5	28	-	85	-	64	2,900	5	<b>1 B6766 48 0</b>						
			-	3,5	38	-	85	-	64	2,900	5	<b>1 B6766 58 0</b>						
	<ul style="list-style-type: none"> <li>VERSION WITH SECURITY FUNCTION (dependent locks): the secondary lock can only be operated when the main lock is in its closed position.</li> <li>2-throw, 6 lever double bit secondary lock</li> <li>4-throw, 6 lever double bit cylinder main lock</li> </ul>	 3 + 3 item 1 00123 00 1	-	3,5	28	-	85	-	64	3,300	1	<b>1 57715 28 0</b>						
			-	3,5	28	-	85	-	64	3,000	5	<b>1 57715 48 0</b>						
	<ul style="list-style-type: none"> <li>VERSION WITH SERVICE LOCK</li> <li>2-throw, 6 lever double bit secondary lock</li> <li>4-throw, 6 lever double bit cylinder main lock</li> </ul>	 3 + 3 item 1 00123 00 1	-	3,5	28	-	85	-	64	3,300	1	<b>1 57716 28 0</b>						
			-	3,5	28	-	85	-	64	3,000	5	<b>1 57716 48 0</b>						
	<ul style="list-style-type: none"> <li>VERSION WITH SECURITY FUNCTION (dependent locks): the secondary lock can only be operated when the main lock is in its closed position.</li> <li>2-throw, 6 lever double bit secondary lock</li> <li>4-throw, 6 lever double bit cylinder main lock</li> </ul>	 3 item 1 00123 00 1	-	3,5	28	-	85	-	64	3,100	1	<b>1 57765 28 0</b>						
			-	3,5	28	-	85	-	64	2,900	5	<b>1 57765 48 0</b>						
	<ul style="list-style-type: none"> <li>VERSION WITH SERVICE LOCK</li> <li>2-throw, 6 lever double bit secondary lock</li> <li>4-throw, 6 lever double bit cylinder main lock</li> </ul>	 3 item 1 00123 00 1	-	3,5	28	-	85	-	64	3,100	1	<b>1 57766 28 0</b>						
			-	3,5	28	-	85	-	64	2,900	5	<b>1 57766 48 0</b>						



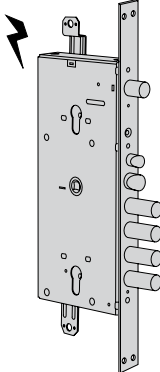
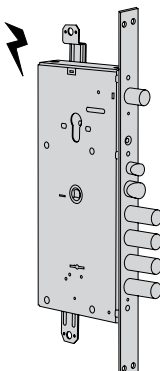

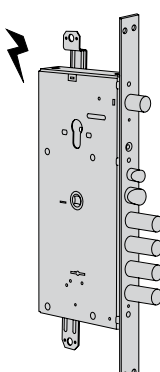
Type	Description	Item key	Dead-bolts							ITEM								
			No.	Projection	Distance	Throws	Distance	Faceplate	Backset	Unit weight Kg	Pieces	Type	Dim.	Hand	Fin.	Pers.	Spec.	
	<ul style="list-style-type: none"> <li>• VERSION WITH SERVICE LOCK AND OPENING LIMITING DEVICE OPERATED BY CYLINDER</li> <li>• 2-throw, cylinder secondary lock</li> <li>• 4-throw, 6 lever double bit main lock</li> <li>• TO ORDER SEPARATELY - Chain for limiting device item 1.06421.10.1/2</li> </ul>	 3 item 1 00123 00 1	-	3,5	28	-	85	-	64	3,100	1	<b>1 57767 28 0</b>						
			-	3,5	28	-	85	-	64	2,900	5	<b>1 57767 48 0</b>						
	<ul style="list-style-type: none"> <li>• VERSION WITH SERVICE LOCK AND OPENING LIMITING DEVICE, OPERATED BY THUMB TURN ONLY FROM INSIDE</li> <li>• 2-throw, thumb turn operated secondary lock</li> <li>• 4-throw, 6 lever double bit main lock</li> <li>• TO ORDER SEPARATELY - Chain for limiting device item 1.06421.10.1/2</li> </ul>	 3 item 1 00123 00 1	-	3,5	28	-	85	-	64	3,100	1	<b>1 57768 28 0</b>						
			-	3,5	28	-	85	-	64	2,900	5	<b>1 57768 48 0</b>						
	<ul style="list-style-type: none"> <li>• VERSION WITH SECURITY FUNCTION (independent locks): the secondary lock can also be operated when the main lock is in its open position.</li> <li>• 2-throw, cylinder secondary lock</li> <li>• 4-throw, 6 lever double bit main lock</li> </ul>	 3 item 1 00123 00 1	-	3,5	28	-	85	-	64	3,100	1	<b>1 B7764 28 0</b>						
			-	3,5	38	-	85	-	64	3,100	1	<b>1 B7764 38 0</b>						
			-	3,5	28	-	85	-	64	2,900	5	<b>1 B7764 48 0</b>						
			-	3,5	38	-	85	-	64	2,900	5	<b>1 B7764 58 0</b>						
	<ul style="list-style-type: none"> <li>• VERSION WITH SECURITY FUNCTION (dependent locks): the secondary lock can only be operated when the main lock is in its closed position.</li> <li>• 2-throw, cylinder secondary lock</li> <li>• 4-throw, 6 lever double bit main lock</li> </ul>	 3 item 1 00123 00 1	-	3,5	28	-	85	-	64	3,100	1	<b>1 B7765 28 0</b>						
			-	3,5	38	-	85	-	64	3,100	1	<b>1 B7765 38 0</b>						
			-	3,5	28	-	85	-	64	2,900	5	<b>1 B7765 48 0</b>						
			-	3,5	38	-	85	-	64	2,900	5	<b>1 B7765 58 0</b>						
	<ul style="list-style-type: none"> <li>• VERSION WITH SERVICE LOCK</li> <li>• 2-throw, cylinder secondary lock</li> <li>• 4-throw, 6 lever double bit main lock</li> </ul>	 3 item 1 00123 00 1	-	3,5	28	-	85	-	64	3,100	1	<b>1 B7766 28 0</b>						
			-	3,5	38	-	85	-	64	3,100	1	<b>1 B7766 38 0</b>						
			-	3,5	28	-	85	-	64	2,900	5	<b>1 B7766 48 0</b>						
			-	3,5	38	-	85	-	64	2,900	5	<b>1 B7766 58 0</b>						



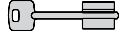

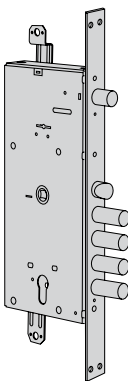
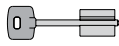
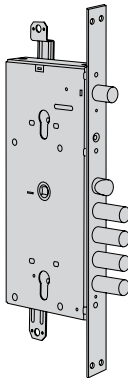
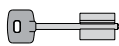
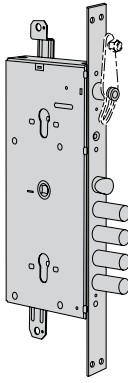
Type	Description	Item key	Dead-bolts							ITEM					
			No.	Projection	Distance	Throws	Distance	Faceplate	Backset	Unit weight Kg	Pieces	Type	Dim. Hand	Fin.	Pers. Spec.
	<ul style="list-style-type: none"> <li>• VERSION WITH SECURITY FUNCTION (dependent locks): the secondary lock can only be operated when the main lock is in its closed position.</li> <li>• 2-throw, cylinder secondary lock</li> <li>• 4-throw NEW CAMBIO FACILE 6 lever double bit main lock</li> </ul>	 3 item 1 00163 00 1	-	3,5	28	-	85	-	64	3,400	1	<b>1 57915 28 A</b>			
			-	3,5	28	-	85	-	64	3,100	5	<b>1 57915 48 A</b>			
		<ul style="list-style-type: none"> <li>• VERSION WITH SERVICE LOCK</li> <li>• 2-throw, cylinder secondary lock</li> <li>• 4-throw NEW CAMBIO FACILE 6 lever double bit main lock</li> </ul>	 3 item 1 00163 00 1	-	3,5	28	-	85	-	64	3,400	1	<b>1 57916 28 A</b>		
				-	3,5	28	-	85	-	64	3,100	5	<b>1 57916 48 A</b>		
	<ul style="list-style-type: none"> <li>• VERSION WITH SERVICE LOCK AND OPENING LIMITING DEVICE OPERATED BY CYLINDER</li> <li>• 2-throw, cylinder secondary lock</li> <li>• 4-throw NEW CAMBIO FACILE 6 lever double bit main lock</li> <li>• TO ORDER SEPARATELY – Chain for limiting device item 1.06421.10.1/2</li> </ul>	 3 item 1 00163 00 1	-	3,5	28	-	85	-	64	3,400	1	<b>1 57917 28 A</b>			
			-	3,5	28	-	85	-	64	3,100	5	<b>1 57917 48 A</b>			
		<ul style="list-style-type: none"> <li>• VERSION WITH SERVICE LOCK AND OPENING LIMITING DEVICE, OPERATED BY THUMB TURN ONLY FROM INSIDE</li> <li>• 2-throw, thumb turn operated secondary lock</li> <li>• 4-throw NEW CAMBIO FACILE 6 lever double bit main lock</li> <li>• TO ORDER SEPARATELY – Chain for limiting device item 1.06421.10.1/2</li> </ul>	 3 item 1 00163 00 1	-	3,5	28	-	85	-	64	3,400	1	<b>1 57918 28 A</b>		
				-	3,5	28	-	85	-	64	3,100	5	<b>1 57918 48 A</b>		
	<ul style="list-style-type: none"> <li>• VERSION WITH SECURITY FUNCTION (dependent locks): the secondary lock can only be operated when the main lock is in its closed position.</li> <li>• 2-throw, cylinder secondary lock</li> <li>• 4-throw NEW CAMBIO FACILE 6 lever double bit main lock, with construction key</li> </ul>	 3 item 1 00163 00 1	-	3,5	28	-	85	-	64	3,400	1	<b>1 57965 28 A</b>			
			-	3,5	28	-	85	-	64	3,100	5	<b>1 57965 48 A</b>			
		<ul style="list-style-type: none"> <li>• VERSION WITH SERVICE LOCK</li> <li>• 2-throw, cylinder secondary lock</li> <li>• 4-throw NEW CAMBIO FACILE 6 lever double bit main lock, with construction key</li> </ul>	 1 item 1 00120 00 1 (construction key)	-	3,5	28	-	85	-	64	3,400	1	<b>1 57966 28 A</b>		
				-	3,5	28	-	85	-	64	3,100	5	<b>1 57966 48 A</b>		

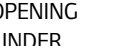

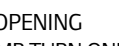

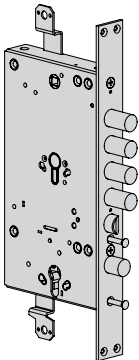
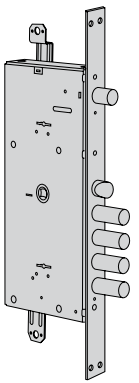

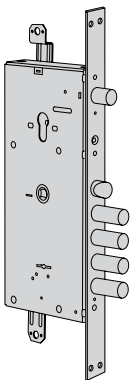



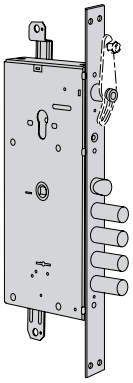
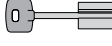
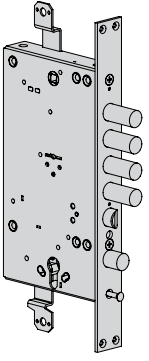

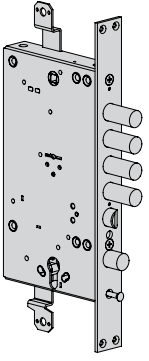

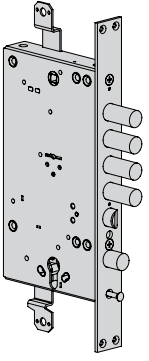



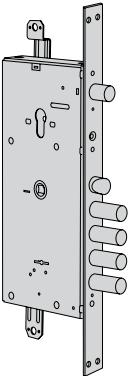

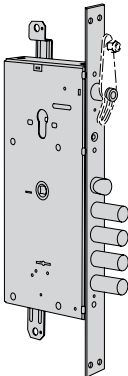
Type	Description	Item key	Dead-bolts							ITEM										
			No.	Projection	Distance	Throws	Distance	Faceplate	Backset	Unit weight Kg	Pieces	Type	Dim. Hand	Fin.	Pers. Spec.					
	<ul style="list-style-type: none"> <li>VERSION WITH SERVICE LOCK AND OPENING LIMITING DEVICE OPERATED BY CYLINDER</li> <li>2-throw, cylinder secondary lock</li> <li>4-throw NEW CAMBIO FACILE 6 lever double bit main lock, with construction key</li> <li>TO ORDER SEPARATELY - Chain for limiting device item 1.06421.10.1/2</li> </ul>	 3 item 1 00163 00 1	-	3,5	28	-	85	-	64	3,400	1	<b>1 57967 28 A</b>								
			-	3,5	28	-	85	-	64	3,100	5	<b>1 57967 48 A</b>								
		 1 item 1 00120 00 1 (construction key)																		
			<ul style="list-style-type: none"> <li>VERSION WITH SERVICE LOCK AND OPENING LIMITING DEVICE, OPERATED BY THUMB TURN ONLY FROM INSIDE</li> <li>2-throw, thumb turn operated secondary lock</li> <li>4-throw NEW CAMBIO FACILE 6 lever double bit main lock, with construction key</li> <li>TO ORDER SEPARATELY - Chain for limiting device item 1.06421.10.1/2</li> </ul>	 3 item 1 00163 00 1	-	3,5	28	-	85	-	64	3,400	1	<b>1 57968 28 A</b>						
					-	3,5	28	-	85	-	64	3,100	5	<b>1 57968 48 A</b>						
				 1 item 1 00120 00 1 (construction key)																
					<ul style="list-style-type: none"> <li>VERSION WITH SECURITY FUNCTION (independent locks): the secondary lock can also be operated when the main lock is in its open position.</li> <li>2-throw, cylinder secondary lock</li> <li>4-throw NEW CAMBIO FACILE 6 lever double bit main lock, with construction key</li> </ul>	 3 item 1 00163 00 1	-	3,5	28	-	85	-	64	3,400	1	<b>1 B7964 28 A</b>				
							-	3,5	38	-	85	-	64	3,400	1	<b>1 B7964 38 A</b>				
 1 item 1 00120 00 1 (construction key)	-					3,5	28	-	85	-	64	3,100	5	<b>1 B7964 48 A</b>						
	-					3,5	38	-	85	-	64	3,100	5	<b>1 B7964 58 A</b>						
	<ul style="list-style-type: none"> <li>VERSION WITH SECURITY FUNCTION (dependent locks): the secondary lock can only be operated when the main lock is in its closed position.</li> <li>2-throw, cylinder secondary lock</li> <li>4-throw NEW CAMBIO FACILE 6 lever double bit main lock, with construction key</li> </ul>					 3 item 1 00163 00 1	-	3,5	28	-	85	-	64	3,400	1	<b>1 B7965 28 A</b>				
							-	3,5	38	-	85	-	64	3,400	1	<b>1 B7965 38 A</b>				
		 1 item 1 00120 00 1 (construction key)	-			3,5	28	-	85	-	64	3,100	5	<b>1 B7965 48 A</b>						
			-			3,5	38	-	85	-	64	3,100	5	<b>1 B7965 58 A</b>						
			<ul style="list-style-type: none"> <li>VERSION WITH SERVICE LOCK</li> <li>2-throw, cylinder secondary lock</li> <li>4-throw NEW CAMBIO FACILE 6 lever double bit main lock, with construction key</li> </ul>			 3 item 1 00163 00 1	-	3,5	28	-	85	-	64	3,400	1	<b>1 B7966 28 A</b>				
							-	3,5	38	-	85	-	64	3,400	1	<b>1 B7966 38 A</b>				
				 1 item 1 00120 00 1 (construction key)	-	3,5	28	-	85	-	64	3,100	5	<b>1 B7966 48 A</b>						
					-	3,5	38	-	85	-	64	3,100	5	<b>1 B7966 58 A</b>						

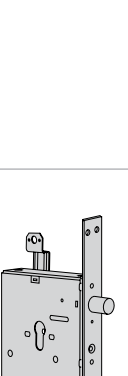

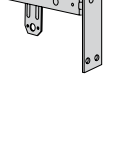





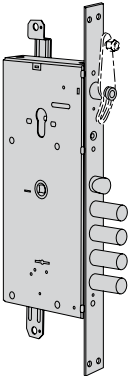

Type	Description	Item key	Dead-bolts								ITEM								
			No.	Projection	Distance	Throws	Distance	Faceplate	Backset	Unit weight Kg	Pieces	Type	Dim.	Hand	Fin.	Pers.	Spec.		
	<ul style="list-style-type: none"> <li>• VERSION WITH SERVICE LOCK</li> <li>• 2-throw cylinder secondary lock</li> <li>• 2-throw cylinder main lock</li> <li>• Electrically controlled dead-locking latch-bolt</li> <li>• Voltage: 12 V ac CE</li> <li>• Slide item 1.06224.50.0</li> </ul>		-	-	28	-	85	35	67	3,800	1	1	16786	28	0				
			-	-	28	-	85	35	67	3,500	5	1	16786	48	0				
	<ul style="list-style-type: none"> <li>• VERSION WITH SERVICE LOCK</li> <li>• 2-throw cylinder secondary lock</li> <li>• Double bit 6 lever main lock</li> <li>• Electrically controlled dead-locking latch-bolt</li> <li>• Voltage: 12 V ac CE</li> <li>• Slide item 1.06224.50.0</li> </ul>	 3 item 1.00122.00.1	-	-	28	-	85	35	67	3,600	1	1	17786	28	0				
			-	-	28	-	85	35	67	3,300	5	1	17786	48	0				
	<ul style="list-style-type: none"> <li>• VERSION WITH SERVICE LOCK</li> <li>• 2-throw cylinder secondary lock</li> <li>• Double bit 6 lever NEW CAMBIO FACILE 4-throw main lock</li> <li>• Electrically controlled dead-locking latch-bolt</li> <li>• Voltage: 12 V ac CE</li> <li>• Slide item 1.06224.50.0</li> </ul>	 3 item 1.00162.00.1	-	-	28	-	85	35	67	3,900	1	1	17936	28	A				
			-	-	28	-	85	35	67	3,600	5	1	17936	48	A				
	<ul style="list-style-type: none"> <li>• VERSION WITH SERVICE LOCK</li> <li>• 2-throw cylinder secondary lock</li> <li>• Double bit 6 lever NEW CAMBIO FACILE 4-throw main lock with construction key</li> <li>• Electrically controlled dead-locking latch-bolt</li> <li>• Voltage: 12 V ac CE</li> <li>• Slide item 1.06224.50.0</li> </ul>	 3 item 1.00162.00.1   1 item 1.00120.00.1 (construction key)	-	-	28	-	85	35	67	3,735	1	1	17986	28	A				
			-	-	28	-	85	35	67	3,700	5	1	17986	48	A				

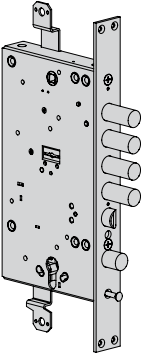
Type	Description	Item key	Dead-bolts								ITEM					
			No.	Projection	Distance	Throws	Distance	Faceplate	Backset	Unit weight Kg	Pieces	Type	Dim.	Hand	Fin.	Pers. Spec.
	<ul style="list-style-type: none"> <li>• VERSION WITH SECURITY FUNCTION (dependent locks): the secondary lock can only be operated when the main lock is in its closed position.</li> <li>• 2-throw, 6 lever double bit secondary lock</li> <li>• 2-throw cylinder main lock</li> </ul>	 3 item 1 00122 00 1	-	-	28	-	85	35	67	3,800	1	<b>1 56735 28 0</b>				
			-	-	28	-	85	35	67	3,500	5	<b>1 56735 48 0</b>				
	<ul style="list-style-type: none"> <li>• VERSION WITH SECURITY FUNCTION (dependent locks): the secondary lock can only be operated when the main lock is in its closed position.</li> <li>• 2-throw, cylinder secondary lock</li> <li>• 2-throw, cylinder main lock</li> </ul>	 3 item 1 00122 00 1	-	-	28	-	85	35	67	3,800	1	<b>1 56736 28 0</b>				
			-	-	28	-	85	35	67	3,500	5	<b>1 56736 48 0</b>				
	<ul style="list-style-type: none"> <li>• VERSION WITH SECURITY FUNCTION (dependent locks): the secondary lock can only be operated when the main lock is in its closed position.</li> <li>• 2-throw, cylinder secondary lock</li> <li>• 2-throw, cylinder main lock</li> </ul>	 3 item 1 00122 00 1	-	-	28	-	85	35	67	3,600	1	<b>1 56785 28 0</b>				
			-	-	28	-	85	35	67	3,300	5	<b>1 56785 48 0</b>				
	<ul style="list-style-type: none"> <li>• VERSION WITH SERVICE LOCK AND OPENING LIMITING DEVICE OPERATED BY CYLINDER</li> <li>• 2-throw, cylinder secondary lock</li> <li>• 2-throw, cylinder main lock</li> <li>• TO ORDER SEPARATELY - Chain for limiting device item 1.06421.10.1/2</li> </ul>	 3 item 1 00122 00 1	-	-	28	-	85	35	67	3,600	1	<b>1 56787 28 0</b>				
			-	-	28	-	85	35	67	3,300	5	<b>1 56787 48 0</b>				
	<ul style="list-style-type: none"> <li>• VERSION WITH SERVICE LOCK AND OPENING LIMITING DEVICE, OPERATED BY THUMB TURN ONLY FROM INSIDE</li> <li>• 2-throw, thumb turn operated secondary lock</li> <li>• 2-throw, cylinder main lock</li> <li>• TO ORDER SEPARATELY - Chain for limiting device item 1.06421.10.1/2</li> </ul>	 3 item 1 00122 00 1	-	-	28	-	85	35	67	3,600	1	<b>1 56788 28 0</b>				
			-	-	28	-	85	35	67	3,300	5	<b>1 56788 48 0</b>				

Type	Description	Item key	Dead-bolts							Unit weight		ITEM						
			No.	Projection	Distance	Throws	Distance	Faceplate	Backset	Kg	Pieces	Type	Dim.	Hand	Fin.	Pers.	Spec.	
	<ul style="list-style-type: none"> <li>VERSION WITH SECURITY FUNCTION (independent locks): the secondary lock can also be operated when the main lock is in its open position.</li> <li>2-throw, cylinder secondary lock</li> <li>2-throw, cylinder main lock</li> </ul>		-	-	28	-	85	35	67	3,600	1	<b>1 B6784 28 0</b>						
			-	-	38	-	85	35	67	3,600	1	<b>1 B6784 38 0</b>						
			-	-	28	-	85	35	67	3,300	5	<b>1 B6784 48 0</b>						
			-	-	38	-	85	35	67	3,300	5	<b>1 B6784 58 0</b>						
	<ul style="list-style-type: none"> <li>VERSION WITH SECURITY FUNCTION (dependent locks): the secondary lock can only be operated when the main lock is in its closed position.</li> <li>2-throw, cylinder secondary lock</li> <li>2-throw, cylinder main lock</li> </ul>		-	-	28	-	85	35	67	3,600	1	<b>1 B6785 28 0</b>						
			-	-	38	-	85	35	67	3,600	1	<b>1 B6785 38 0</b>						
			-	-	28	-	85	35	67	3,300	5	<b>1 B6785 48 0</b>						
			-	-	38	-	85	35	67	3,300	5	<b>1 B6785 58 0</b>						
<ul style="list-style-type: none"> <li>VERSION WITH SERVICE LOCK</li> <li>2-throw, cylinder secondary lock</li> <li>2-throw, cylinder main lock</li> </ul>		-	-	28	-	85	35	67	3,600	1	<b>1 B6786 28 0</b>							
		-	-	38	-	85	35	67	3,600	1	<b>1 B6786 38 0</b>							
		-	-	28	-	85	35	67	3,300	5	<b>1 B6786 48 0</b>							
		-	-	38	-	85	35	67	3,300	5	<b>1 B6786 58 0</b>							
	<ul style="list-style-type: none"> <li>VERSION WITH SECURITY FUNCTION (dependent locks): the secondary lock can only be operated when the main lock is in its closed position.</li> <li>2-throw, 6 lever double bit secondary lock</li> <li>4-throw, 6 lever double bit cylinder main lock</li> </ul>	 3+3 item 1 00122 00 1	-	-	28	-	85	35	67	3,800	1	<b>1 57735 28 0</b>						
			-	-	28	-	85	35	67	3,500	5	<b>1 57735 48 0</b>						
	<ul style="list-style-type: none"> <li>VERSION WITH SERVICE LOCK</li> <li>2-throw, 6 lever double bit secondary lock</li> <li>4-throw, 6 lever double bit cylinder main lock</li> </ul>		 3+3 item 1 00122 00 1	-	-	28	-	85	35	67	3,800	1	<b>1 57736 28 0</b>					
				-	-	28	-	85	35	67	3,500	5	<b>1 57736 48 0</b>					
	<ul style="list-style-type: none"> <li>VERSION WITH SECURITY FUNCTION (dependent locks): the secondary lock can only be operated when the main lock is in its closed position.</li> <li>2-throw, cylinder secondary lock</li> <li>4-throw, 6 lever double bit cylinder main lock</li> </ul>	 3 item 1 00122 00 1	-	-	28	-	85	35	67	3,600	1	<b>1 57785 28 0</b>						
			-	-	28	-	85	35	67	3,300	5	<b>1 57785 48 0</b>						
	<ul style="list-style-type: none"> <li>VERSION WITH SERVICE LOCK</li> <li>2-throw, cylinder secondary lock</li> <li>4-throw, 6 lever double bit cylinder main lock</li> </ul>		 3 item 1 00122 00 1	-	-	28	-	85	35	67	3,600	1	<b>1 57786 28 0</b>					
				-	-	28	-	85	35	67	3,300	5	<b>1 57786 48 0</b>					

Type	Description	Item key	Dead-bolts								ITEM									
			No.	Projection	Distance	Throws	Distance	Faceplate	Backset	Unit weight Kg	Pieces	Type	Dim.	Hand	Fin.	Pers.	Spec.			
	<ul style="list-style-type: none"> <li>• VERSION WITH SERVICE LOCK AND OPENING LIMITING DEVICE OPERATED BY CYLINDER</li> <li>• 2-throw, cylinder secondary lock</li> <li>• 4-throw, 6 lever double bit main lock</li> <li>• TO ORDER SEPARATELY – Chain for limiting device item 1.06421.10.1/2</li> </ul>	 3 item 1 00122 00 1	-	-	28	-	85	35	67	3,600	1	1	<b>57787 28 0</b>							
			-	-	28	-	85	35	67	3,300	5	1	<b>57787 48 0</b>							
			-	-	28	-	85	35	67	3,600	1	1	<b>57788 28 0</b>							
			-	-	28	-	85	35	67	3,300	5	1	<b>57788 48 0</b>							
	<ul style="list-style-type: none"> <li>• VERSION WITH SECURITY FUNCTION (independent locks): the secondary lock can also be operated when the main lock is in its open position.</li> <li>• 2-throw, cylinder secondary lock</li> <li>• 4-throw, 6 lever double bit main lock</li> </ul>	 3 item 1 00122 00 1	-	-	28	-	85	35	67	3,600	1	1	<b>B7784 28 0</b>							
			-	-	38	-	85	35	67	3,600	1	1	<b>B7784 38 0</b>							
			-	-	28	-	85	35	67	3,300	5	1	<b>B7784 48 0</b>							
			-	-	38	-	85	35	67	3,300	5	1	<b>B7784 58 0</b>							
	<ul style="list-style-type: none"> <li>• VERSION WITH SECURITY FUNCTION (dependent locks): the secondary lock can only be operated when the main lock is in its closed position.</li> <li>• 2-throw, cylinder secondary lock</li> <li>• 4-throw, 6 lever double bit main lock</li> </ul>	 3 item 1 00122 00 1	-	-	28	-	85	35	67	3,600	1	1	<b>B7785 28 0</b>							
			-	-	38	-	85	35	67	3,600	1	1	<b>B7785 38 0</b>							
			-	-	28	-	85	35	67	3,300	5	1	<b>B7785 48 0</b>							
			-	-	38	-	85	35	67	3,300	5	1	<b>B7785 58 0</b>							
	<ul style="list-style-type: none"> <li>• VERSION WITH SERVICE LOCK</li> <li>• 2-throw, cylinder secondary lock</li> <li>• 4-throw, 6 lever double bit main lock</li> </ul>	 3 item 1 00122 00 1	-	-	28	-	85	35	67	3,600	1	1	<b>B7766 28 0</b>							
			-	-	38	-	85	35	67	3,600	1	1	<b>B7766 38 0</b>							
			-	-	28	-	85	35	67	3,300	5	1	<b>B7766 48 0</b>							
			-	-	38	-	85	35	67	3,300	5	1	<b>B7766 58 0</b>							

Type	Description	Item key	Dead-bolts							ITEM							
			No.	Projection	Distance	Throws	Distance	Faceplate	Backset	Unit weight Kg	Pieces	Type	Dim.	Hand	Fin.	Pers.	Spec.
	<ul style="list-style-type: none"> <li>VERSION WITH SECURITY FUNCTION (dependent locks): the secondary lock can only be operated when the main lock is in its closed position.</li> <li>2-throw, cylinder secondary lock</li> <li>4-throw NEW CAMBIO FACILE</li> <li>6 lever double bit main lock</li> </ul>	 3 item 1 00162 00 1	-	-	28	-	85	35	67	3,900	1	<b>1 57935 28 A</b>					
			-	-	28	-	85	35	67	3,600	5	<b>1 57935 48 A</b>					
	<ul style="list-style-type: none"> <li>VERSION WITH SERVICE LOCK</li> <li>2-throw, cylinder secondary lock</li> <li>4-throw NEW CAMBIO FACILE</li> <li>6 lever double bit main lock</li> </ul>	 3 item 1 00162 00 1	-	-	28	-	85	35	67	3,900	1	<b>1 57936 28 A</b>					
			-	-	28	-	85	35	67	3,600	5	<b>1 57936 48 A</b>					
	<ul style="list-style-type: none"> <li>VERSION WITH SERVICE LOCK AND OPENING LIMITING DEVICE OPERATED BY CYLINDER</li> <li>2-throw, cylinder secondary lock</li> <li>4-throw NEW CAMBIO FACILE</li> <li>6 lever double bit main lock</li> <li>TO ORDER SEPARATELY - Chain for limiting device item 1.06421.10.1/2</li> </ul>	 3 item 1 00162 00 1	-	-	28	-	85	35	67	3,900	1	<b>1 57937 28 A</b>					
			-	-	28	-	85	35	67	3,600	5	<b>1 57937 48 A</b>					
	<ul style="list-style-type: none"> <li>VERSION WITH SERVICE LOCK AND OPENING LIMITING DEVICE, OPERATED BY THUMB TURN ONLY FROM INSIDE</li> <li>2-throw, thumb turn operated secondary lock</li> <li>4-throw NEW CAMBIO FACILE</li> <li>6 lever double bit main lock</li> <li>TO ORDER SEPARATELY - Chain for limiting device item 1.06421.10.1/2</li> </ul>	 3 item 1 00162 00 1	-	-	28	-	85	35	67	3,900	1	<b>1 57938 28 A</b>					
			-	-	28	-	85	35	67	3,600	5	<b>1 57938 48 A</b>					
	<ul style="list-style-type: none"> <li>VERSION WITH SECURITY FUNCTION (dependent locks): the secondary lock can only be operated when the main lock is in its closed position.</li> <li>2-throw, cylinder secondary lock</li> <li>4-throw NEW CAMBIO FACILE</li> <li>6 lever double bit main lock, with construction key</li> </ul>	 3 item 1 00162 00 1  1 item 1 00120 00 1 (construction key)	-	-	28	-	85	35	67	4,000	1	<b>1 57985 28 A</b>					
			-	-	28	-	85	35	67	3,700	5	<b>1 57985 48 A</b>					
	<ul style="list-style-type: none"> <li>VERSION WITH SERVICE LOCK</li> <li>2-throw, cylinder secondary lock</li> <li>4-throw NEW CAMBIO FACILE</li> <li>6 lever double bit main lock, with construction key</li> </ul>	 3 item 1 00162 00 1  1 item 1 00120 00 1 (construction key)	-	-	28	-	85	35	67	4,000	1	<b>1 57986 28 A</b>					
			-	-	28	-	85	35	67	3,700	5	<b>1 57986 48 A</b>					

Type	Description	Item key	Dead-bolts								ITEM										
			No.	Projection	Distance	Throws	Distance	Faceplate	Backset	Unit weight Kg	Pieces	Type	Dim.	Hand	Fin.	Pers. Spec.					
	<ul style="list-style-type: none"> <li>• VERSION WITH SERVICE LOCK AND OPENING LIMITING DEVICE OPERATED BY CYLINDER</li> <li>• 2-throw, cylinder secondary lock</li> <li>• 4-throw NEW CAMBIO FACILE 6 lever double bit main lock, with construction key</li> <li>• TO ORDER SEPARATELY - Chain for limiting device item 1.06421.10.1/2</li> </ul>	 3 item 1 00162 00 1	-	-	28	-	85	35	67	4,000	1	1	<b>57987 28 A</b>								
			-	-	28	-	85	35	67	3,700	5	1	<b>57987 48 A</b>								
		 1 item 1 00120 00 1 (construction key)	-	-	28	-	85	35	67	4,000	1	1	<b>57988 28 A</b>								
			-	-	28	-	85	35	67	3,700	5	1	<b>57988 48 A</b>								
			<ul style="list-style-type: none"> <li>• VERSION WITH SECURITY FUNCTION (independent locks): the secondary lock can also be operated when the main lock is in its open position.</li> <li>• 2-throw, cylinder secondary lock</li> <li>• 4-throw NEW CAMBIO FACILE 6 lever double bit main lock, with construction key</li> </ul>	 3 item 1 00162 00 1	-	-	28	-	85	35	67	4,000	1	1	<b>B7984 28 A</b>						
					-	-	38	-	85	35	67	4,000	1	1	<b>B7984 38 A</b>						
				 1 item 1 00120 00 1 (construction key)	-	-	28	-	85	35	67	3,700	5	1	<b>B7984 48 A</b>						
					-	-	38	-	85	35	67	3,700	5	1	<b>B7984 58 A</b>						
				<ul style="list-style-type: none"> <li>• VERSION WITH SECURITY FUNCTION (dependent locks): the secondary lock can only be operated when the main lock is in its closed position.</li> <li>• 2-throw, cylinder secondary lock</li> <li>• 4-throw NEW CAMBIO FACILE 6 lever double bit main lock, with construction key</li> </ul>	 3 item 1 00162 00 1	-	-	28	-	85	35	67	4,000	1	1	<b>B7985 28 A</b>					
						-	-	38	-	85	35	67	4,000	1	1	<b>B7985 38 A</b>					
 1 item 1 00120 00 1 (construction key)	-				-	28	-	85	35	67	3,700	5	1	<b>B7985 48 A</b>							
	-				-	38	-	85	35	67	3,700	5	1	<b>B7985 58 A</b>							
	<ul style="list-style-type: none"> <li>• VERSION WITH SERVICE LOCK</li> <li>• 2-throw, cylinder secondary lock</li> <li>• 4-throw NEW CAMBIO FACILE 6 lever double bit main lock, with construction key</li> </ul>			 3 item 1 00162 00 1	-	-	28	-	85	35	67	4,000	1	1	<b>B7986 28 A</b>						
					-	-	38	-	85	35	67	4,000	1	1	<b>B7986 38 A</b>						
		 1 item 1 00120 00 1 (construction key)	-	-	28	-	85	35	67	3,700	5	1	<b>B7986 48 A</b>								
			-	-	38	-	85	35	67	3,700	5	1	<b>B7986 58 A</b>								

CISA S.p.A. reserves the right to make any changes to the products illustrated in this catalogue without prior notice. All measurements are in millimetres.

